

STC 2P025 Series Solenoid Valve

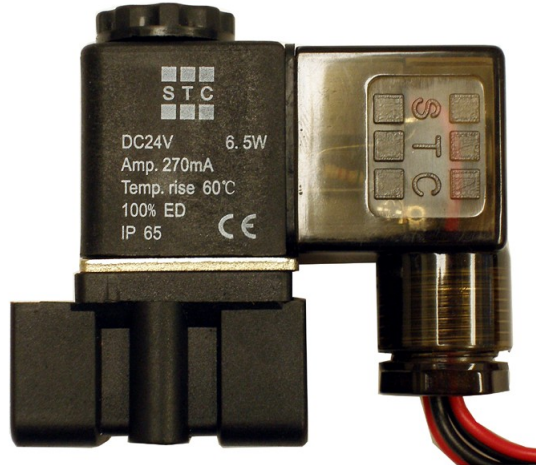

2P025 Series Solenoid Valve Specifications

Valve Model	2P025
Valve Type	2 Way, Normally Closed (NC)
Action	Direct Acting (Poppet), Response Time <20msec
Cv (Orifice)	0.23 (2 mm)
Operating Pressure	0 to 115 PSI
Operating Temperature	14-122° F(-20 to 50°C)
Port Size (NPT)	1/8" or 1/4"
Body Materials	Engineered Nylon
Armature Tube Assembly	Brass; Option: Stainless Steel
Seal Materials	NBR (Buna); Option: Viton, EPDM
Coil Power	3W-8W (Pressure Dependent)
Coil Duty	100% ED
Coil Locking Nut	M8X0.75 Threads
Voltage/Coil (Power)	± 10% of Specified Voltage
Service	Air, Liquid, Water

2P025 Series Solenoid Valve Components

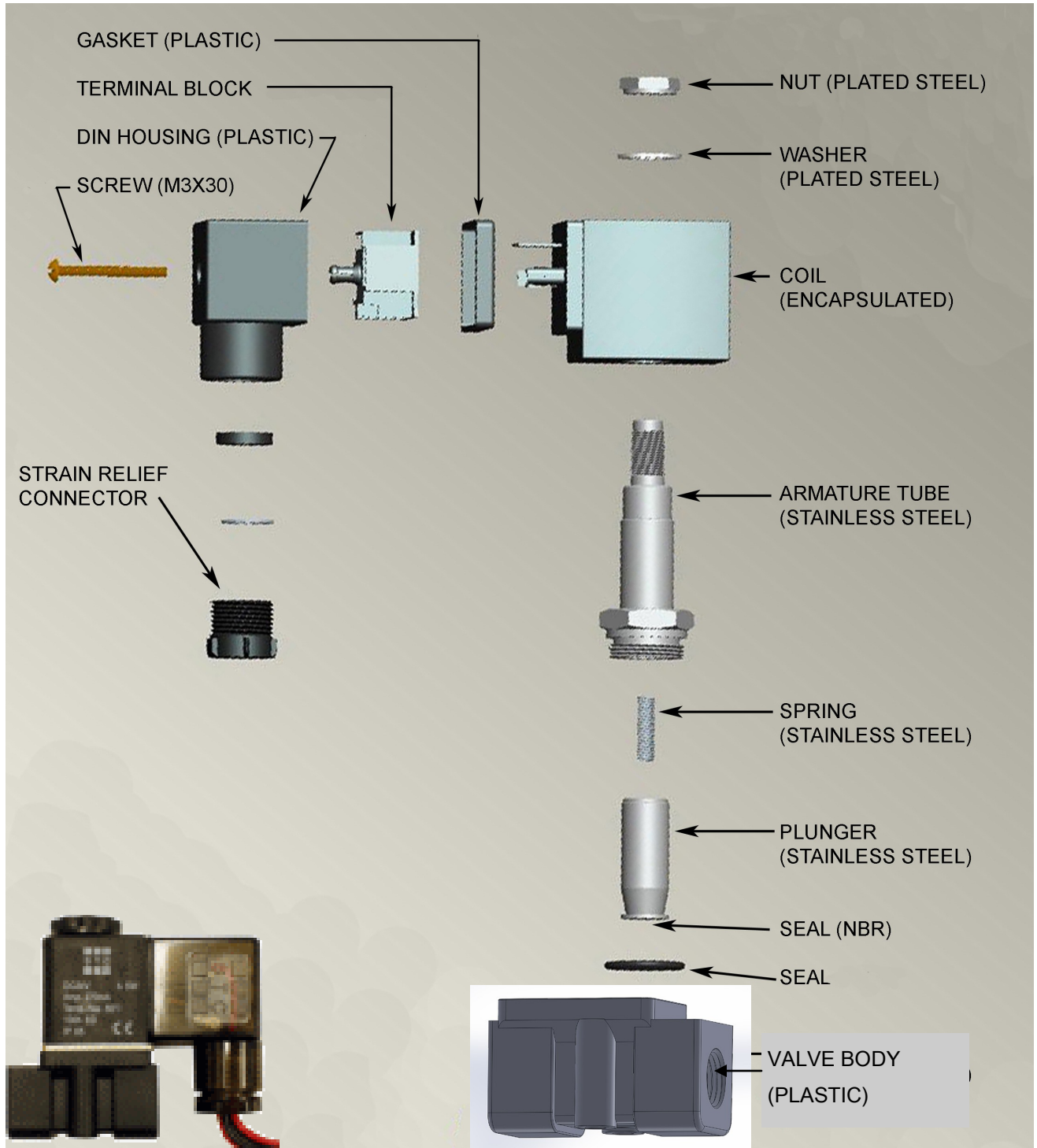

Installation and Operation:

To connect the valve Inlet and Outlet:

Connect the inlet and outlet in the direction of the arrow marked on the valve.

To install coil:

Put the coil onto the armature tube of the valve. Put the lock-washer and nut onto the armature tube. Hand tighten the nut, then use a wrench to tighten the nut to a quarter turn; **do not over-tighten the nut, it may cause the armature tube to fail pre-maturely.**

To connect DIN coil:

1. Remove the Philip screw from the plastic housing and unplug it from the DIN coil.
2. From the screw opening, push the terminal block out from the plastic housing.
3. Note the 1, 2 and ground markings on underside of DIN enclosure.
4. For DC DIN Coil, Connect 1 to Positive, 2 to Negative.
5. For AC DIN Coil, connect 1 to HOT wire, 2 to Neutral wire, and if required connect
6. **Do not energize the coil without installing it onto the valve, it will burn the coil and create fire hazards.**

Safety Note: Standard valves are supplied with continuous duty coils. The proper class of insulation for the service is indicated on the coil. The coil temperature may become hot after being energized for extended periods, but it is normal. Do not energize the coil without installing it onto the valve or connect the coil to a wrong voltage, as it may overheat and damage the coil; although the coil is made of flame retarded material, misuse of the coil in this manner could create fire hazards and generate smoke or burning odor which indicates excessive coil temperature and should disconnect the power to the coil immediately.

Operation: The 2P025 series solenoid valve is direct acting, it does not require a minimum operating differential pressure. As shown below, when the coil is energized (right diagram), it lifts the solenoid plunger, which normally rests on the valve seat and lifts it to open the main valve orifice. When the coil is de-energized (right diagram), the spring force the plunger return to the valve seat to close the valve orifice.

These valves are equipped with Teflon (PTFE) seals which is not elastic but is formable. It is because of this seal property, if the valve is used in low temperature, there may be small leak and the valve needs to be broken-in to form a good mating surface between the seal and the valve orifice. Although the valves have been broken-in at the factory level to make sure there is no leak, due to shipping and installation, the broken-in mating surface may have shifted and needs to be broken-in again, and this is very common. This is accomplished by cycling the valve ON/OFF quickly at the operating pressure until no leak is observed.

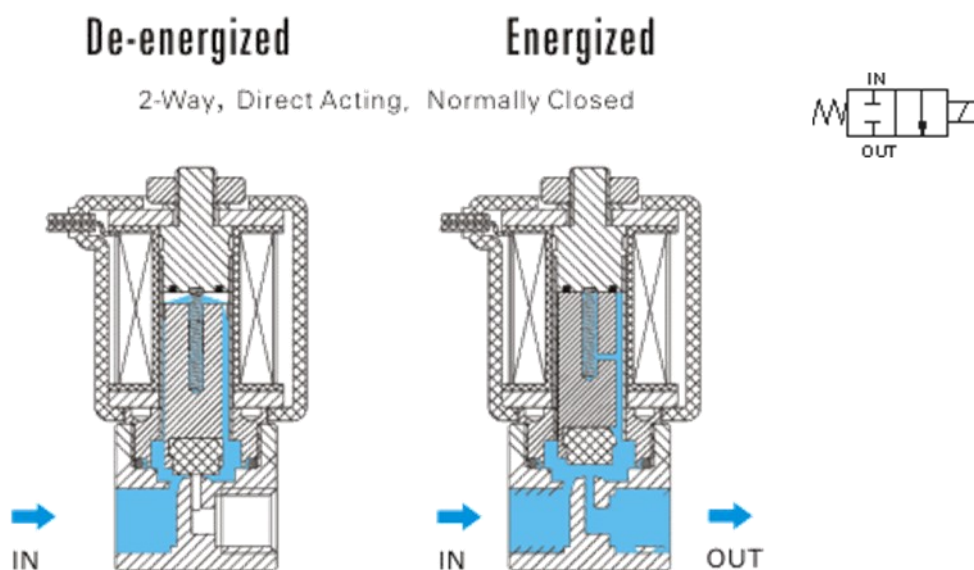

2P025 DIMENSIONS (MM)

TYPE: 2P025-06
2P025-08
unit=mm

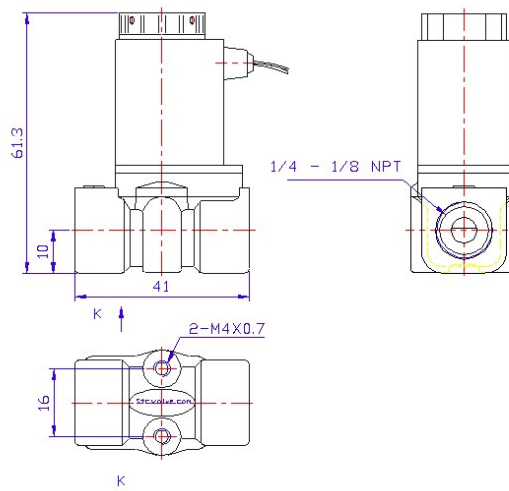

2-Way Direct Acting Valves

Models 2H012, 2P025, 2V025, 3S025-050, 2W010-040

Installation Procedure

Warning: Do NOT over tighten the nut holding the coil to the armature tube. Over tightening may result in damage to the welded joint.

Attaching a Coil to a Valve:

1. After wiring the coil, fit the coil assembly over the armature tube. Ensure that the threads of the tube are accessible.
2. Fit the spring or lock washer over the assembly.
 - For spring washers, the concave side should be oriented toward the coil.
3. Tighten the nut over the washer by hand.
 - For spring washers, tighten the nut further until the spring coil is almost completely flat.
 - For lock washers, tighten the nut another quarter turn.

Installation Procedure:

1. Connect the default outlet to the connector indicated by an arrow (2P025, 2W040) or the number “1” (2S050). The default outlet on model 2V is the farther port from the armature tube.
2. Connect the default inlet to the remaining connector.

Maintenance and Troubleshooting

Notes:

- After an extended period of operation, if you do not hear a clicking sound when the valve is operational, and the wiring is correct, the coil may be burned out and must be replaced. This commonly occurs when input voltages are higher than the coil's specifications.
- Using valves at low temperature may have small leak when first activated. To fix this, cycle the valve at the highest operating pressure available until there is no leak, this will create a proper mating surface between the seal and the valve orifice seat.

Procedure:

1. Remove any coils attached to the valve.
2. Unscrew the holding plate (for models 2P025 and 2V025) and the armature tube and remove it from the valve body. The plunger and spring are not fastened to the tube and will fall out.
3. Check for any debris that may have collected on the plunger and the hole in the center of the valve.
4. Place the spring back in the plunger, and insert the plunger back into the armature tube.
5. Screw the armature tube and holding plate back into the valve.

Reference Figures:

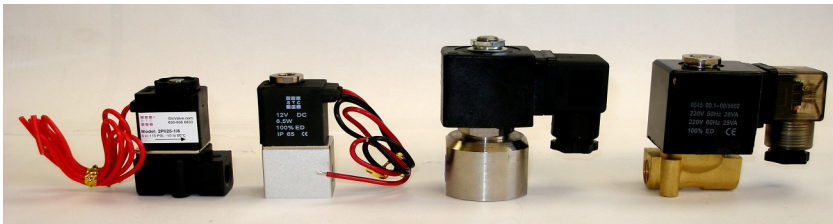

Figure 1: [left]: 2P025 [center left] 2V025 [center right] 2S050 [right] 2W040.



2H012

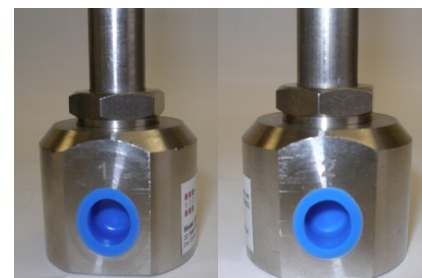
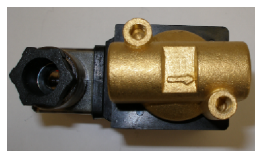

Figure 2: Model 2P025 and 2W040 indicator arrows are on the valve body.

Figure 3: Numbering shown on model 2S050, above the connectors.

Terms and Conditions

By purchasing from SIZTO TECH CORPORATION (STC), you agree to these TERMS AND CONDITIONS. No other terms shall apply except as agreed in writing signed by us. We reserve the right to correct typographic errors and reject orders.

SHIPMENTS:

All shipments are F.O.B. 892 Commercial Street, Palo Alto, CA 94303, USA. Most orders are shipped via UPS Standard Ground unless instructions accompany order. Outside the UPS zones, shipment will be made Best Way. The responsibility for goods delay, lost or damaged in transit rests with the carrier and purchaser. Purchaser may purchase shipping insurance to cover lost or damaged products caused by shipping.

RETURN OF MERCHANDISE:

No merchandise is accepted for return 30 days after delivery date. No credit allowed on merchandise shipped as ordered and returned without obtaining an authorization number IN ADVANCE. A 20% restocking charge applies to all returns, and transportation charges must be fully prepaid. We will pay **ground** transportation charges on re-sent or returned merchandise due to STC's error.

Shortages & Mis-Shipments: Any shortages or mis-shipment must be reported within 15 days.

CANCELLATION POLICY:

Blanket order can be canceled 90 days before scheduled ship date. There will be a 10% charge if a blanket order is cancel within 90 days of scheduled ship date, and a 20% charge if cancel within 60 days. Regular order for non-custom parts can be canceled any time before the order is shipped. For custom parts, a 30% down payment is required either at the time of order or 90 days prior to scheduled ship date, whichever comes later.

Remittances should be sent to:

Sizto Tech Corporation, 892 Commercial Street, Palo Alto, CA 94303, USA

Credit Card Payments: Visa, MasterCard, Discover, or American Express Accepted

International Customers: Advance Payment Required via Bank Wire, Cashier's Check or Approved Credit Card.

Credit Application: To establish a net 30 day account, please mail or fax three trade references with complete mailing addresses and account numbers.

LIMITED WARRANTY – IMPORTANT NOTICE TO PURCHASER:

Sizto Tech Corporation (STC) only warrants this product to be free from defects in materials and workmanship at the time of shipment. This limited warranty expires one year after delivery to the end-user. STC's entire obligation to the Purchaser for breach of this limited warranty shall be limited to replacement of the defective product or refund of the original purchase price of this product, at STC's option. Purchaser has thirty (30) days to return the goods after STC has agreed to accept the return. All freight charges on returned material shall be paid by the Purchaser. STC's limited warranty shall not apply, however, to the product that have been subjected to misuse, alteration, accident or negligence during handling or storage.

DISCLAIMER OF IMPLIED WARRANTIES:

All implied warranties, which may arise by implication of law or application of course of dealing or usage of trade, including, but not limited to, implied warranties of merchantability or fitness for a particular purpose are expressly excluded. There are no warranties, which extend beyond the description of the faced hereof. The end user is solely responsible for the suitability and fitness of this product selected for a particular application.

OBLIGATIONS

You warrant, represent and agree: (1) to comply with all laws; (2) that our sale and shipment of the product will not, by export thereof, your legal status or otherwise, cause us to violate any law; and (3) to indemnify us against any losses from a failure by you or a third party to comply with law or these terms and conditions, or from use of the product.

SAFETY

WARNING: Improper Selection or Failure to follow Usage Instructions of the products described on the Sizto Tech Corporation (STC) Internet Site and its related publications can cause Death, Personal Injury, and Property Damage. All system set-ups require the supervision of a qualified individual who is familiar with installation, inspection and testing through training or experience.

IMPORTANT NOTICE:

All prices are subject to change without notice. We continuously improve the products, and we reserve the right to change specifications without incurring any obligation to incorporate new factors in equipment previously sold.



Sizto Tech Corporation

892 Commercial Street
Palo Alto, CA 94303 USA

Tel: 650-856 8833 | Fax: 650-856 8811

Email: Sales@StcValve.com; www.StcValve.com